

## MODEL CUB5 - MINIATURE ELECTRONIC 8-DIGIT DUAL COUNTER AND RATE INDICATOR



- LCD, REFLECTIVE OR GREEN/RED LED BACKLIGHTING
- 0.46" (11.7 mm) HIGH DIGITS
- OPTIONAL SETPOINT OUTPUT CARD
- OPTIONAL SERIAL COMMUNICATIONS CARD (RS232 or RS485)
- OPTIONAL USB PROGRAMMING CARD
- OPERATES FROM 9 TO 28 VDC POWER SOURCE
- PROGRAMMABLE SCALING FOR COUNT AND RATE
- BI-DIRECTIONAL COUNTING, UP/DOWN CONTROL
- QUADRATURE SENSING (UP TO 4 TIMES RESOLUTION)
- BUILT-IN BATCH COUNTING CAPABILITY
- DISPLAY COLOR CHANGE CAPABILITY AT SETPOINT OUTPUT
- NEMA 4X/IP65 SEALED FRONT BEZEL

### GENERAL DESCRIPTION

The CUB5 provides the user the ultimate in flexibility, from its complete user programming to the optional setpoint control and communication capability. The meter can be programmed as a single or dual counter with rate indication capability. The display can be toggled either manually or automatically between the selected displays.

The CUB5 display has 0.46" (11.7 mm) high digits. The LCD is available in two versions, reflective (CUB5R000) and backlight (CUB5B000). The backlight version is user selectable for green or red backlighting with variable display intensity.

The counter is programmable for one of eight different count modes, including bi-directional and quadrature. When programmed as a dual counter, each counter has a separate scale factor and decimal points. In the counter/rate indicator mode, each have their own scaling and decimal point read-outs in different engineering units. The internal batch counter can be used to count setpoint output activations.

The meter has two separate inputs which provide different functions depending on which operating mode is selected. Input A accepts the signal for the Count and/or Rate displays, while Input B accepts the signal for the Count display or direction control. In the anti-coincidence mode, both inputs are monitored simultaneously so that no counts are lost. The resulting display can be chosen as the sum or difference of the two inputs. The Rate Indicator has programmable low (minimum) and high (maximum) update times to provide optimal display response at any input frequency. There is a programmable user input that can be programmed to perform a variety of functions.

The capability of the CUB5 can be easily expanded with the addition of option cards. Setpoint capability is field installable with the addition of the single setpoint relay output card or the dual setpoint solid state output card. Serial communications capability for RS232 or RS485 is added with a serial option card.

The CUB5 can be powered from an optional Red Lion Micro-Line/Sensor Power Supply (MLPS), which attaches directly to the back of a CUB5. The MLPS is powered from 85 to 250 VAC and provides up to 400 mA to drive the unit and sensors.

### COUNTER

The CUB5 receives incoming pulses and multiplies them by the Count Scale Factor to obtain the desired reading for the count display. Input A accepts the signal for the count and Input B is used for quadrature, dual counter, anti-coincidence counting, or up/down control counting.

### RATE

The rate indicator utilizes the signal at Input A to calculate the rate value using a time interval method (1/tau). The unit counts on the negative edge of the input pulses. After the programmed minimum update time elapses and the next negative edge occurs, the unit calculates the input rate based on the number of edges that occurred during the elapsed time. The input rate is then multiplied by the rate scaling value to calculate the rate display.

At slower rates, averaging can be accomplished by programming the rate minimum update time for the desired response. Extensive scaling capabilities allow practically any desired reading at very slow count rates.

### SAFETY SUMMARY

All safety related regulations, local codes and instructions that appear in this literature or on equipment must be observed to ensure personal safety and to prevent damage to either the instrument or equipment connected to it. If equipment is used in a manner not specified by the manufacturer, the protection provided by the equipment may be impaired.

Do not use this meter to directly command motors, valves, or other actuators not equipped with safeguards. To do so can be potentially harmful to persons or equipment in the event of a fault to the meter.



**CAUTION: Risk of Danger.**  
 Read complete instructions prior to installation and operation of the unit.



**CAUTION: Risk of electric shock.**

### DIMENSIONS In inches (mm)

Note: Recommended minimum clearance (behind the panel) for mounting clip installation is 2.15" (54.6) H x 3.00" (76.2) W.

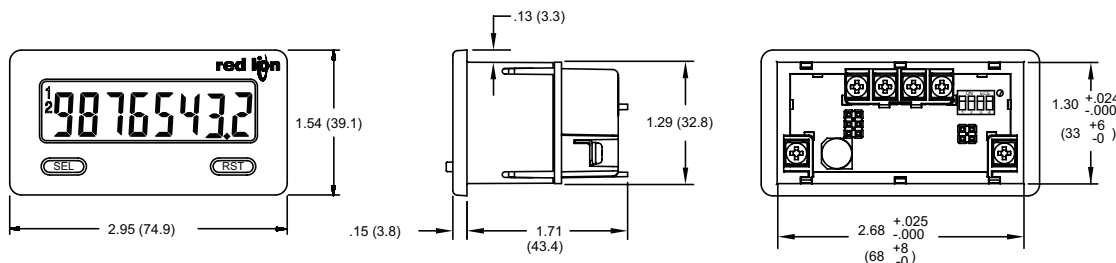

# ORDERING INFORMATION

TYPE	MODEL NO.	DESCRIPTION	PART NUMBER
CUB5	CUB5R	Dual Counter & Rate Indicator with Reflective Display	CUB5R000
	CUB5B	Dual Counter & Rate Indicator with Backlight Display	CUB5B000
Optional Plug-in Cards	CUB5RLY	Single Relay Option Card	CUB5RLY0
	CUB5SNK	Dual Sinking Open Collector Output card	CUB5SNK0
	CUB5COM	RS485 Serial Communications Card	CUB5COM1
		RS232 Serial Communications Card	CUB5COM2
	CUB5USB	USB Programming Card	CUB5USB0
Accessories	MLPS	+12 VDC Micro-Line Power Supply, 85 to 250 VAC source, 400 mA max out	MLPS1000
		+24 VDC Micro-Line Power Supply, 85 to 250 VAC source, 200 mA max out	MLPS2000
	CBLPRO	Programming Cable RS232 (RJ11-DB9)	CBLPROG0
	CBPRO	Programming Cable RS485 (RJ11-DB9)	CBPRO007
	SFCRD	Crimson PC Configuration Software for Windows 98, ME, 2000, XP <sup>1</sup>	SFCRD200
	CBLUSB	USB Programming Cable	CBLUSB00

<sup>1</sup> Crimson software is a free download from <http://www.redlion.net>

# GENERAL METER SPECIFICATIONS

- DISPLAY:** 8 digit LCD 0.46" (11.7 mm) high digits  
**CUB5R000:** Reflective LCD with full viewing angle  
**CUB5B000:** Transmissive LCD with selectable red or green LED backlight, viewing angle optimized. Display color change capability with output state when using an output module.
- POWER:** Input voltage range is +9 to +28 VDC with short circuit and input polarity protection. Must use an RLC model MLPS or an NEC Class 2 or Limited Power Source (LPS) rated power supply.

MODEL NO.	DISPLAY COLOR	INPUT CURRENT @ 9 VDC WITHOUT CUB5RLY0	INPUT CURRENT @ 9 VDC WITH CUB5RLY0
CUB5R000	---	10 mA	30 mA
CUB5B000	Red (max intensity)	85 mA	115 mA
CUB5B000	Green (max intensity)	95 mA	125 mA

- COUNTER DISPLAYS:**  
**Counter A:** 8-digits, enabled in all count modes  
 Display Range: -9999999 to 9999999  
 Overflow Indication: Display flashes "Err"
   
**Counter B:** 7-digits, enabled in Dual Counter Mode or batch counting  
 Display Designator: "b" to the left side of the display  
 Display Range: 0 to 9999999 (positive count only)  
 Overflow Indication: Display flashes "bErr"
   
**Maximum Count Rates:** 50% duty cycle  
 Without setpoint option card: 20 KHz (all count modes)  
 With setpoint option card: 20 KHz for any count mode except Dual Counter (16 KHz), Quadrature x2 (14 KHz) and Quadrature x4 (13 KHz).
- RATE DISPLAY:** 6-digits, may be enabled or disabled in any count mode  
**Display Designator:** "R" to the left side of the display  
**Display Range:** 0 to 999999  
**Over Range Display:** "R 0.0000"  
**Maximum Frequency:** 20 KHz  
**Minimum Frequency:** 0.01 Hz  
**Accuracy:** ±0.01%
- COUNT/RATE SIGNAL INPUTS (INP A and INP B):**  
**Input A:** DIP switch selectable to accept pulses from a variety of sources. See Section 2.0 Setting the DIP Switches for Input A specifications.  
**Input B:** Logic signals only  
 Trigger levels:  $V_{IL} = 0.7 \text{ V max}$ ;  $V_{IH} = 2.4 \text{ V min}$ ;  $V_{MAX} = 28 \text{ VDC}$   
 Current sinking: Internal 10KΩ pull-up resistor to +9 to 28 VDC  
 Filter (LO Freq.): Damping capacitor provided for switch contact bounce. Limits input frequency to 50 Hz and input pulse widths to 10 msec min.
- USER INPUT (USR):** Programmable input. Connect to input common (INP COMM) to activate function. Internal 10KΩ pull-up resistor to +9 to 28 VDC.  
**Threshold Levels:**  $V_{IL} = 0.7 \text{ V max}$ ;  $V_{IH} = 2.4 \text{ V min}$ ;  $V_{MAX} = 28 \text{ VDC}$   
**Response Time:** 5 msec typ.; 50 msec debounce (activation and release)

- MEMORY:** Nonvolatile E<sup>2</sup>PROM memory retains all programming parameters and count values when power is removed.
- CONNECTIONS:** Wire clamping screw terminals  
**Wire Strip Length:** 0.3" (7.5 mm)  
**Wire Gauge:** 30-14 AWG copper wire  
**Torque:** 5 inch-lbs (0.565 N-m) max.
- CONSTRUCTION:** This unit is rated for NEMA 4X/IP65 requirements for outdoor use. Installation Category I, Pollution Degree 2. High impact plastic case with clear viewing window. Panel gasket and mounting clip included.
- ENVIRONMENTAL CONDITIONS:**  
**Operating Temperature Range for CUB5R000:** -35 to 75 °C  
**Operating Temperature Range for CUB5B000 depends on display color and intensity level as per below:**

	INTENSITY LEVEL	TEMPERATURE
Red Display	1 & 2	-35 to 75°C
	3	-35 to 70°C
	4	-35 to 60°C
	5	-35 to 50°C
	Green Display	1 & 2
	3	-35 to 65°C
	4	-35 to 50°C
	5	-35 to 35°C

- Storage Temperature:** -35 to 85 °C  
**Operating and Storage Humidity:** 0 to 85% max. relative humidity (non-condensing)  
**Vibration to IEC 68-2-6:** Operational 5-500 Hz, 5 g  
**Shock to IEC 68-2-27:** Operational 40 g  
**Altitude:** Up to 2000 meters
- CERTIFICATIONS AND COMPLIANCES:**  
**CE Approved**  
 EN 61326-1 Immunity to Industrial Locations  
 Emission CISPR 11 Class A  
 IEC/EN 61010-1  
 RoHS Compliant  
 UL Recognized Component: File #E179259  
 UL Listed: File #E137808  
 Type 4X Outdoor Enclosure rating (Face only)  
 IP65 Enclosure rating (Face only)  
 IP20 Enclosure rating (Rear of unit)  
*Refer to EMC Installation Guidelines for additional information.*
  - WEIGHT:** 3.2 oz (100 g)

# OPTIONAL PLUG-IN CARDS

## ADDING OPTION CARDS

The CUB5 meters can be fitted with optional output cards and/or serial communications cards. The details for the plug-in cards can be reviewed in the specification section below. The plug-in cards, that are sold separately, can be installed initially or at a later date.



**WARNING: Disconnect all power to the unit before installing Plug-in card.**

### SINGLE RELAY OUTPUT CARD (One setpoint only)

**Type:** Single FORM-C relay  
**Isolation To Sensor & User Input Commons:** 1400 Vrms for 1 min.  
**Working Voltage:** 150 Vrms  
**Contact Rating:** 1 amp @ 30 VDC resistive; 0.3 amp @ 125 VAC resistive  
**Life Expectancy:** 100,000 minimum operations  
**Response Time:**  
 Turn On Time: 4 msec. max.  
 Turn Off Time: 4 msec. max.

### DUAL SINKING OUTPUT CARD (One or two setpoints)

**Type:** Non-isolated switched DC, N Channel open drain MOSFET  
**Current Rating:** 100 mA max.

**V<sub>DS ON</sub>:** 0.7 V @ 100 mA  
**V<sub>DS MAX</sub>:** 30 VDC  
**Offstate Leakage Current:** 0.5 mA max.

### RS485 SERIAL COMMUNICATIONS CARD

**Type:** RS485 multi-point balanced interface (non-isolated)  
**Baud Rate:** 300 to 38.4k  
**Data Format:** 7/8 bits; odd, even, or no parity  
**Bus Address:** 0 to 99; max 32 meters per line  
**Transmit Delay:** Selectable, 2 msec min. or 50 msec min.

### RS232 SERIAL COMMUNICATIONS CARD

**Type:** RS232 half duplex (non-isolated)  
**Baud Rate:** 300 to 38.4k  
**Data Format:** 7/8 bits; odd, even, or no parity

### USB PROGRAMMING CARD

**Type:** USB virtual comms port  
**Connection:** Type B  
**Baud Rate:** 300 to 38.4k  
**Unit Address:** 0 to 99

# 1.0 INSTALLING THE METER

## INSTALLATION

The meter meets NEMA 4X/IP65 requirements when properly installed. The unit is intended to be mounted into an enclosed panel. Prepare the panel cutout to the dimensions shown. Remove the panel latch from the unit. Slide the panel gasket over the rear of the unit to the back of the bezel. The unit should be installed fully assembled. Insert the unit into the panel cutout.

While holding the unit in place, push the panel latch over the rear of the unit so that the tabs of the

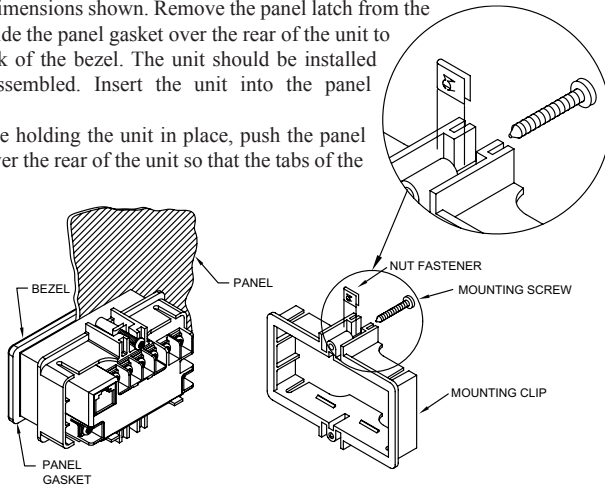

panel latch engage in the slots on the case. The panel latch should be engaged in the farthest forward slot possible. To achieve a proper seal, tighten the latch screws evenly until the unit is snug in the panel (Torque to approx. 28 to 36 in-oz [0.202 to 0.26 N-m]). Do not over-tighten the screws.

## INSTALLATION ENVIRONMENT

The unit should be installed in a location that does not exceed the operating temperature and provides good air circulation. Placing the unit near devices that generate excessive heat should be avoided.

The bezel should only be cleaned with a soft cloth and neutral soap product. Do NOT use solvents. Continuous exposure to direct sunlight may accelerate the aging process of the bezel.

Do not use tools of any kind (screwdrivers, pens, pencils, etc.) to operate the keypad of the unit.

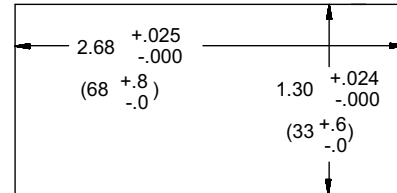

# 2.0 SETTING THE DIP SWITCHES

To access the switches, remove the rear cover of the meter as described below. A bank of 4 switches is located in the upper right hand corner. After setting the switches, install any optional plug-in cards before replacing the rear cover (see next section).



**Warning:** Exposed line voltage exists on the circuit boards. Remove all power to the meter and load circuits before accessing inside of the meter.

## REMOVING THE REAR COVER

To remove the rear cover, locate the cover locking tab below the 2nd and 3rd input terminals. To release the tab, insert a small, flat blade screwdriver between the tab and the plastic wall below the terminals. Inserting the screwdriver will provide enough pressure to release the tab locks. To replace the cover, align the cover with the input terminals and press down until the cover snaps into place.

## SETTING THE INPUT DIP SWITCHES

The meter has four dip switches for Input A and Input B that must be set before applying power.

### SWITCH 1

**LOGIC:** Input A trigger levels  $V_{IL} = 1.25 \text{ V max.}$ ;  $V_{IH} = 2.75 \text{ V min.}$ ;  $V_{MAX} = 28 \text{ VDC}$

**MAG:** 200 mV peak input sensitivity; 100 mV hysteresis; maximum input voltage:  $\pm 40 \text{ V peak}$  (28 Vrms); Must also have SRC switch ON. (Not recommended with counting applications.)

### SWITCH 2

**SNK:** Adds internal 7.8 K $\Omega$  pull-up resistor to +9 to 28 VDC,  $I_{MAX} = 3.8 \text{ mA}$ .

**SRC:** Adds internal 3.9 K $\Omega$  pull-down resistor, 7.2 mA max. @ 28 VDC max.

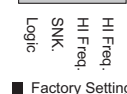
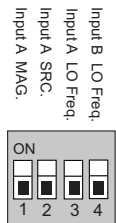

■ Factory Setting

## SWITCHES 3 and 4

**HI Frequency:** Removes damping capacitor and allows max. frequency.

**LO Frequency:** Adds a damping capacitor for switch contact bounce. Limits input frequency to 50 Hz and input pulse widths to 10 msec.

# 3.0 INSTALLING PLUG-IN CARDS

The Plug-in cards are separately purchased option cards that perform specific functions. The cards plug into the main circuit board of the meter. After installing the cards, replace the rear cover before wiring the meter.

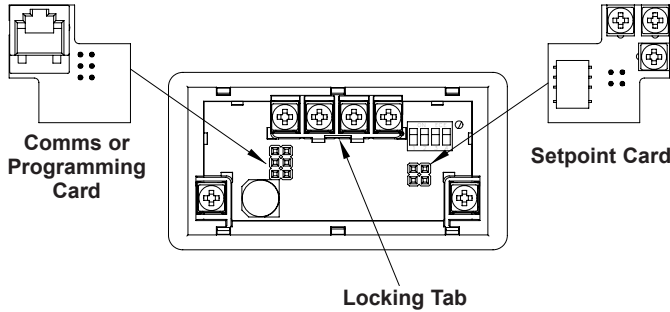

**CAUTION:** The Plug-in cards and main circuit board contain static sensitive components. Before handling the cards, discharge static charges from your body by touching a grounded bare metal object. Ideally, handle the cards at a static controlled clean workstation. Also, only handle the cards by the edges. Dirt, oil or other contaminants that may contact the cards can adversely affect circuit operation.

## REPLACING THE REAR COVER

To replace the rear cover, align the cover with the input terminals and press down until the cover snaps into place.

# 4.0 WIRING THE METER

## WIRING OVERVIEW

Electrical connections are made via screw-clamp terminals located on the back of the meter. All conductors should conform to the meter's voltage and current ratings. All cabling should conform to appropriate standards of good installation, local codes and regulations. It is recommended that the power supplied to the meter (DC or AC) be protected by a fuse or circuit breaker.

Strip the wire, leaving approximately 0.3" (7.5 mm) bare lead exposed (stranded wires should be tinned with solder.) Insert the lead under the correct screw-clamp terminal and tighten until the wire is secure. (Pull wire to verify tightness.) Each terminal can accept up to one #14 AWG (2.55 mm) wire, two #18 AWG (1.02 mm), or four #20 AWG (0.61 mm).

## EMC INSTALLATION GUIDELINES

Although this meter is designed with a high degree of immunity to Electro-Magnetic Interference (EMI), proper installation and wiring methods must be followed to ensure compatibility in each application. The type of the electrical noise, source or coupling method into the meter may be different for various installations. The meter becomes more immune to EMI with fewer I/O connections. Cable length, routing, and shield termination are very important and can mean the difference between a successful or troublesome installation. Listed below are some EMC guidelines for successful installation in an industrial environment.

- The meter should be mounted in a metal enclosure, which is properly connected to protective earth.
- Use shielded (screened) cables for all Signal and Control inputs. The shield (screen) pigtail connection should be made as short as possible. The connection point for the shield depends somewhat upon the application. Listed below are the recommended methods of connecting the shield, in order of their effectiveness.
  - Connect the shield only at the panel where the unit is mounted to earth ground (protective earth).
  - Connect the shield to earth ground at both ends of the cable, usually when the noise source frequency is above 1 MHz.
  - Connect the shield to common of the meter and leave the other end of the shield unconnected and insulated from earth ground.

- Never run Signal or Control cables in the same conduit or raceway with AC power lines, conductors feeding motors, solenoids, SCR controls, and heaters, etc. The cables should be ran in metal conduit that is properly grounded. This is especially useful in applications where cable runs are long and portable two-way radios are used in close proximity or if the installation is near a commercial radio transmitter.
- Signal or Control cables within an enclosure should be routed as far as possible from contactors, control relays, transformers, and other noisy components.
- In extremely high EMI environments, the use of external EMI suppression devices, such as ferrite suppression cores, is effective. Install them on Signal and Control cables as close to the unit as possible. Loop the cable through the core several times or use multiple cores on each cable for additional protection. Install line filters on the power input cable to the unit to suppress power line interference. Install them near the power entry point of the enclosure. The following EMI suppression devices (or equivalent) are recommended:
  - Ferrite Suppression Cores for signal and control cables:
    - Fair-Rite # 0443167251 (RLC# FCOR0000)
    - TDK # ZCAT3035-1330A
    - Steward # 28B2029-0A0
  - Line Filters for input power cables:
    - Schaffner # FN610-1/07 (RLC# LFIL0000)
    - Schaffner # FN670-1.8/07
    - Corcom # 1 VR3

*Note: Reference manufacturer's instructions when installing a line filter.*
- Long cable runs are more susceptible to EMI pickup than short cable runs. Therefore, keep cable runs as short as possible.
- Switching of inductive loads produces high EMI. Use of snubbers across inductive loads suppresses EMI.
  - Snubber: RLC# SNUB0000.

## 4.1 POWER WIRING

### DC Power

+9 to +28 VDC: +VDC  
Power Common: -VDC

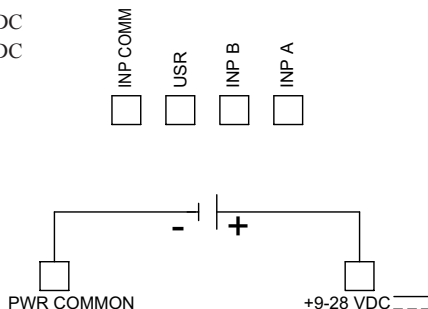

## 4.2 USER INPUT WIRING

### Sinking Logic

INP COMM } Connect external switching device between the  
USR } User Input terminal and Input Common.

The user input of the meter is internally pulled up to +9 to +28 V with 10 K resistance. The input is active when it is pulled low (<1 .0 V).

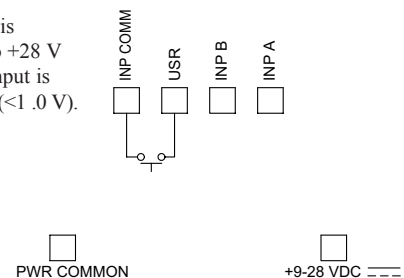

### 4.3 INPUT WIRING



**CAUTION:** Power common (PWR COMMON) is NOT isolated from input common (INP COMM). In order to preserve the safety of the meter application, the power common must be suitably isolated from hazardous live earth referenced voltage; or input common must be at protective earth ground potential. If not, hazardous voltage may be present at the Signal or User Inputs and input common terminals. Appropriate considerations must then be given to the potential of the input common with respect to earth ground; and the common of the plug-in cards with respect to input common.

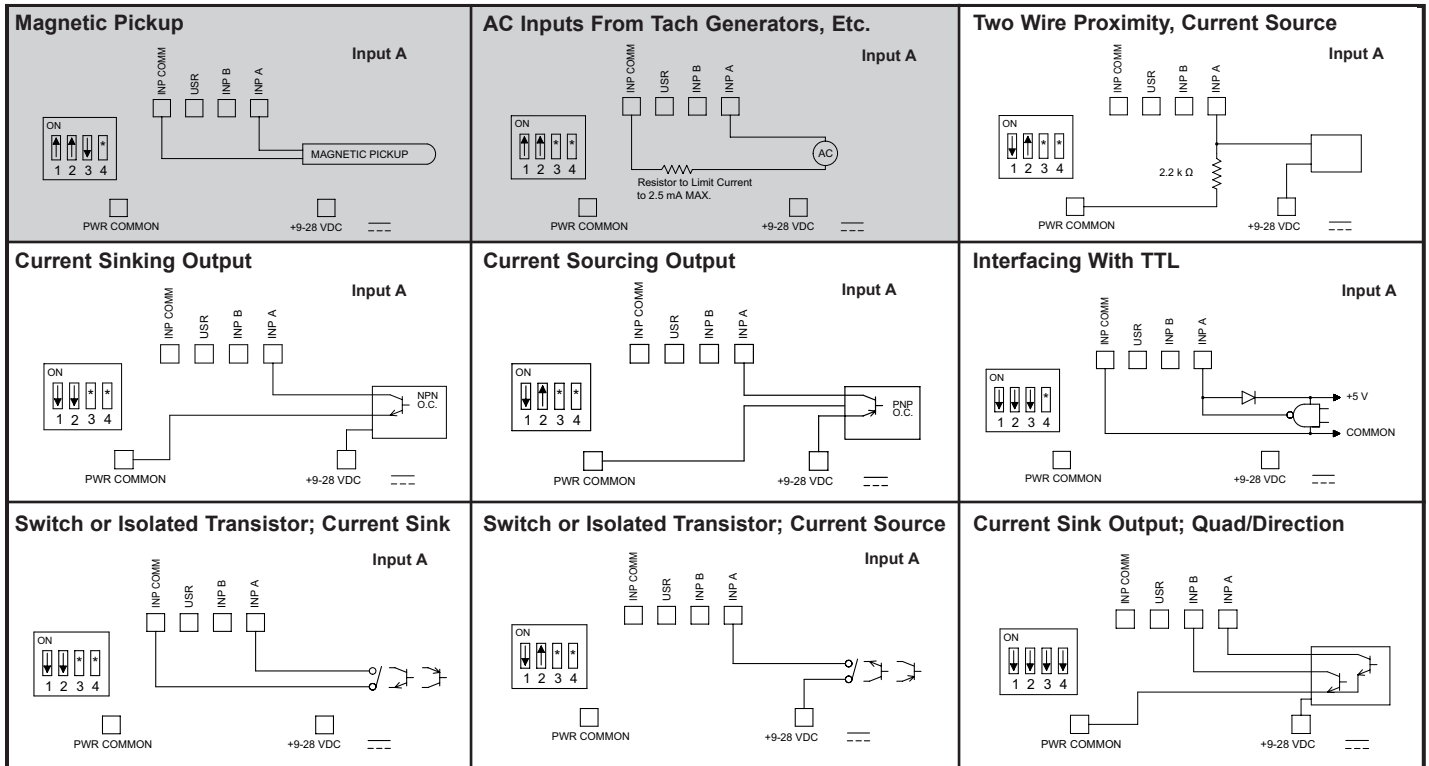

\* Switch position is application dependent.

Shaded areas not recommended for counting applications.

### 4.4 SETPOINT (OUTPUT) WIRING

#### SINGLE SETPOINT RELAY PLUG-IN CARD

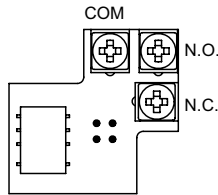

#### ELECTRICAL CONNECTIONS

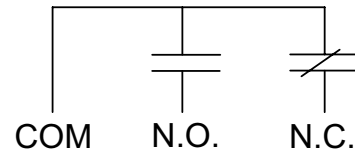

#### DUAL SETPOINT N-FET OPEN DRAIN PLUG-IN CARD

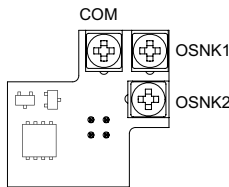

#### ELECTRICAL CONNECTIONS

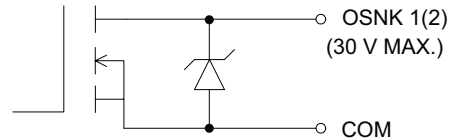

Note: Output Common is not isolated from DC Power Common. Load must be wired between OSNK terminal and V+ of the load supply.

### 4.5 SERIAL COMMUNICATION WIRING

#### SERIAL COMMUNICATIONS PLUG-IN CARD

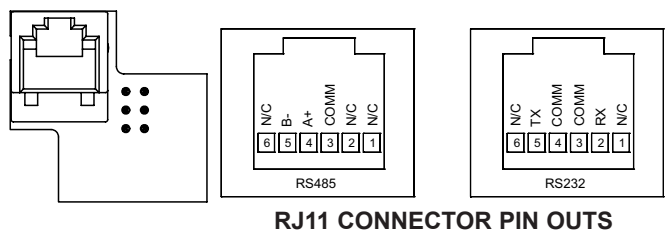

### 4.6 USB PROGRAMMING

#### USB PROGRAMING PLUG-IN CARD

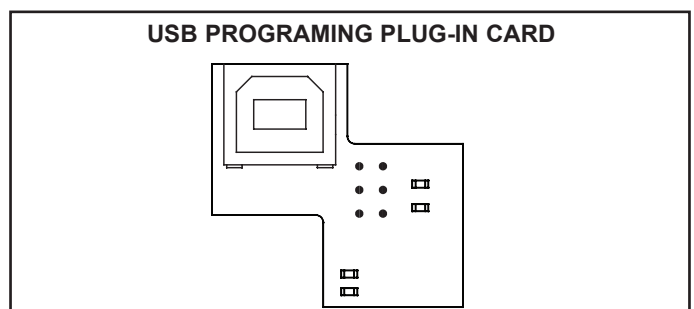

# 5.0 REVIEWING THE FRONT BUTTONS AND DISPLAY

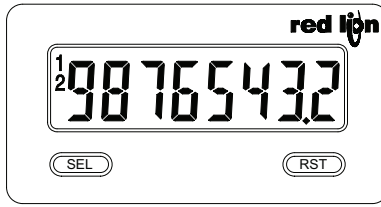

KEY	DISPLAY MODE OPERATION	ENTERING PROGRAM MODE	PROGRAMMING MODE OPERATION
SEL	Index display through enabled values	Press and hold for 2 seconds to activate	Store selected parameter and index to next parameter
RST	Resets count display(s) and/or outputs		Advances through the program menu/ Increments selected parameter value or selection

## OPERATING MODE DISPLAY DESIGNATORS

“R” - To the left of the display is the rate value.  
 - Counter A has no designator.

“b” - To the left of the display is the Counter B value (dual count or batch).  
 “1” and “2” - Indicates setpoint 1 and 2 output status.

Pressing the **SEL** button toggles the meter through the selected displays. If display scroll is enabled, the display will toggle automatically every four seconds between the rate and count values.

# 6.0 PROGRAMMING THE METER

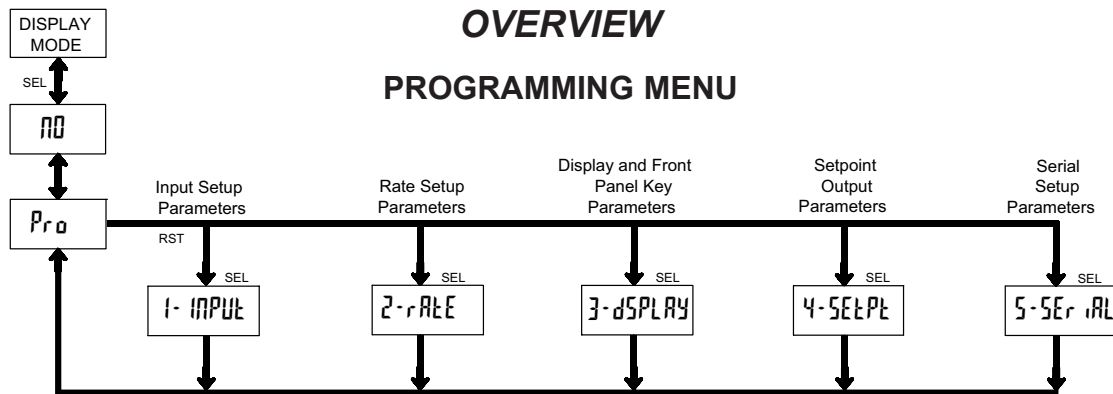

## PROGRAMMING MODE ENTRY (SEL KEY)

It is recommended all programming changes be made off line, or before installation. The meter normally operates in the Display Mode. No parameters can be programmed in this mode. The Programming Mode is entered by pressing and holding the **SEL** key. If it is not accessible then it is locked by either a security code, or a hardware lock.

## MODULE ENTRY (SEL & RST KEYS)

The Programming Menu is organized into separate modules. These modules group together parameters that are related in function. The display will alternate between **Pr0** and the present module. The **RST** key is used to select the desired module. The displayed module is entered by pressing the **SEL** key.

## MODULE MENU (SEL KEY)

Each module has a separate module menu (which is shown at the start of each module discussion). The **SEL** key is pressed to advance to a particular parameter to be changed, without changing the programming of preceding parameters. After completing a module, the display will return to **Pr0**. Programming may continue by accessing additional modules.

## SELECTION / VALUE ENTRY

For each parameter, the display alternates between the present parameter and the selections/value for that parameter. The **RST** key is used to move through the selections/values for that parameter. Pressing the **SEL** key, stores and activates the displayed selection/value. This also advances the meter to the next parameter.

For numeric values, press the **RST** key to access the value. The right hand most digit will begin to flash. Pressing the **RST** key again increments the digit by one or the user can hold the **RST** key and the digit will automatically scroll. The **SEL** key will advance to the next digit. Pressing and holding the **SEL** key will enter the value and move to the next parameter.

## PROGRAMMING MODE EXIT (SEL KEY)

The Programming Mode is exited by pressing the **SEL** key with **Pr0** displayed. This will commit any stored parameter changes to memory and return the meter to the Display Mode. (If power loss occurs before returning to the Display Mode, verify recent parameter changes.)

## PROGRAMMING TIPS

It is recommended to start with Module 1 for counting or Module 2 for rate. When programming is complete, it is recommended to record the parameter programming and lock out parameter programming with the user input or programming security code.

## FACTORY SETTINGS

Factory settings may be completely restored in Module 3. This is useful when encountering programming problems.

## ALTERNATING SELECTION DISPLAY

In the explanation of the modules, the following dual display with arrows will appear. This is used to illustrate the display alternating between the parameter on top and the parameter's factory setting on the bottom. In most cases, selections and values for the parameter will be listed on the right.

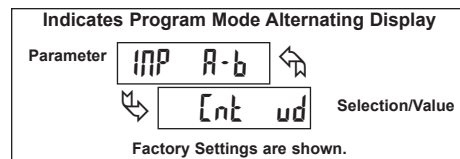

# 6.1 MODULE 1 - INPUT SETUP PARAMETERS (1- INPUT)

## PARAMETER MENU

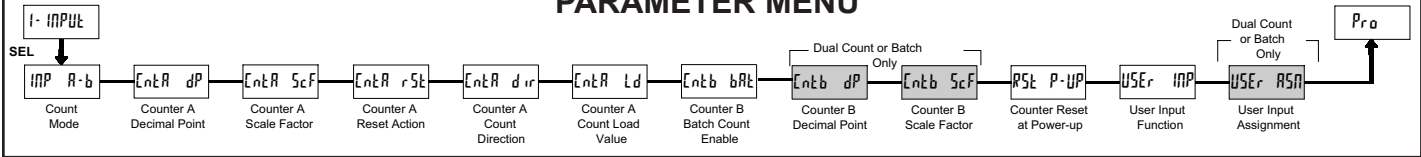

Shaded area selections only apply when Counter B is enabled (Dual Counter mode or batch counter).

### COUNT MODE

INP A-b

←

↵

Cnt ud

RRtE Cnt

dUAL Cnt

QUAd 1

QUAd 2

QUAd 4

Add Add

Add Sub

QUAd 1

QUAd 2

QUAd 4

Select the count mode that corresponds with your application. The input actions are shown in the boxes below. For simple counting applications, it is recommended to use Count with Direction for the count mode. Simply leave the direction input unconnected.

DISPLAY	MODE	INPUT A ACTION	INPUT B ACTION
Cnt ud	Count with Direction	Counter A	Counter A Direction
RRtE Cnt	Rate/Counter	Rate only	Counter A Add
dUAL Cnt	Dual Counter	Counter A Add	Counter B Add
QUAd 1	Quadrature x1	Count A	Quad A
QUAd 2	Quadrature x2	Count A	Quad A
QUAd 4	Quadrature x4	Count A	Quad A
Add Add	2 Input Add/Add	Counter A Add	Counter A Add
Add Sub	2 Input Add/Subtract	Counter A Add	Counter A Subtract

Note: The Rate indicator signal is derived from Input A in all count modes.

### COUNTER A DECIMAL POSITION

CntA dP

←

↵

0

00

000

00000

00

0000

000000

This selects the decimal point position for Counter A. The selection will also affect Counter A scale factor calculations.

### COUNTER A SCALE FACTOR

CntA ScF

←

↵

0.0000

00000.1 to 999999

The number of input counts is multiplied by the scale factor to obtain the desired process value. A scale factor of 1.0000 will result in the display of the actual number of input counts. (Details on scaling calculations are explained at the end of this section.)\*

### COUNTER A RESET ACTION

CntA rSt

←

↵

to ZErO

to Ld

When Counter A is reset, it returns to Zero or Counter A Count Load value. This reset action applies to all Counter A resets, except a setpoint generated Counter Auto Reset programmed in Module 4.

### COUNTER A COUNT DIRECTION

CntA dir

←

↵

NO

REV

Reverse (REV) switches the normal Counter A count direction shown in the Count Mode parameter chart.

### COUNTER A COUNT LOAD VALUE

CntA Ld

←

↵

00000500

-.9999999 to 99999999

Counter A resets to this value if Reset to Count Load action is selected.

### COUNTER B BATCH COUNT ENABLE

CntB bRt

←

↵

NO

NO

SP1

SP1-2

SP2

The Counter B batch count function internally counts the number of output activations of the selected setpoint(s). The count source for the batch counter can be SP1, SP2 or both. Batch counting is available in all count modes except Dual Counter, which uses an external input signal for Counter B. This parameter only appears if a Setpoint Output option card is installed.

### COUNTER B DECIMAL POSITION

CntB dP

←

↵

0

00

000

00000

00

0000

000000

This selects the decimal point position for Counter B. The selection will also affect Counter B scale factor calculations.

### COUNTER B SCALE FACTOR

CntB ScF

←

↵

0.0000

00000.1 to 999999

The number of input or batch counts is multiplied by the scale factor to obtain the desired process value. A scale factor of 1.0000 will result in the display of the actual number of input or batch counts. (Details on scaling calculations are explained at the end of this section.)\*

### COUNTER RESET AT POWER-UP

RSt P-UP

←

↵

NO

YES

NO

Count b

Count A both A-b

The selected counter(s) will reset at each meter power-up.

\* For value entry instructions, refer to selection/value entry in the Programming The Meter section.

## SCALING FOR COUNT INDICATION

The CUB5's scale factor is factory set to 1, to provide one count on the display for each pulse that is input to the unit. In many applications, there will not be a one-to-one correspondence between input pulses and display units. Therefore, it is necessary for the CUB5 to scale or multiply the input pulses by a scale factor to achieve the desired display units (feet, meters, gallons, etc.)

The Count Scale Factor Value can range from 00.0001 to 99.9999. It is important to note that the precision of a counter application cannot be improved by using a scale factor greater than one. To accomplish greater precision, more pulse information must be generated per measuring unit. The following formula is used to calculate the scale factor.

$$\text{Scale Factor} = \frac{\text{Desired Display Units}}{\text{Number of Pulses}} \times \text{Decimal Point Position}$$

### WHERE:

**Desired Display Units:** Count display units acquired after pulses that occurred.

**Number of Pulses:** Number of pulses required to achieve the desired display units.

### Decimal Point Position:

0	=	1
0.0	=	10
0.00	=	100
0.000	=	1000
0.0000	=	10000
0.00000	=	100000

**EXAMPLE:** The counter display is used to indicate the total number of feet used in a process. It is necessary to know the number of pulses for the desired units to be displayed. The decimal point is selected to show the resolution in hundredths.

$$\text{Scale Factor} = \frac{\text{Desired Display Units}}{\text{Number of Pulses}} \times \text{Decimal Point Position}$$

Given that 128 pulses are equal to 1 foot, display total feet with a one-hundredth resolution.

$$\text{Scale Factor} = \frac{1.00}{128} \times 100$$

$$\text{Scale Factor} = 0.007812 \times 100$$

$$\text{Scale Factor} = 0.7812$$

## USER INPUT FUNCTION

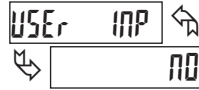

DISPLAY	MODE	DESCRIPTION
NO	No Function	User Input disabled.
Pr o Loc	Program Mode Lock-out	See Programming Mode Access chart. (Module 3)
Inh ib it	Inhibit	Inhibit counting for the selected counter(s).
rESEt	Maintained Reset	Level active reset of the selected counter(s).
StorE	Store	Freeze display of selected counter(s) while allowing counts to accumulate internally.
Stor-rSt	Store and Reset	Edge triggered reset of the selected counter(s) after storing the count.
d-SELEct	Display Select *	Advance once for each activation
d-LEUEL	Display Intensity Level *	Increase intensity one level for each activation. (backlight version only)
d-COLOr	Backlight Color *	Change backlight color with each activation (backlight version only)
Pr int	Print Request	Serial transmit of the active parameters selected in the Print Options (Module 5)
Pr int-rSt	Print and Reset *	Same as Print Request followed by a momentary reset of the selected counter(s).
rESEt-1	Setpoint 1 Reset *	Reset Setpoint 1 output
rESEt-2	Setpoint 2 Reset *	Reset Setpoint 2 output
rESEt-12	Setpoint 1 and 2 Reset *	Reset Setpoint 1 and 2 outputs

Note: \* indicates Edge Triggered function. Other functions are Level Active (maintained)

## USER INPUT ASSIGNMENT

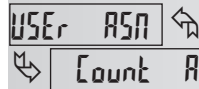

Count A Count B both A-B

The User Input Assignment is only active when Counter B is enabled and the User Input performs a Reset, Inhibit or Store function on one or both counters.

## 6.2 MODULE 2 - RATE SETUP PARAMETERS (2-rATE)

### PARAMETER MENU

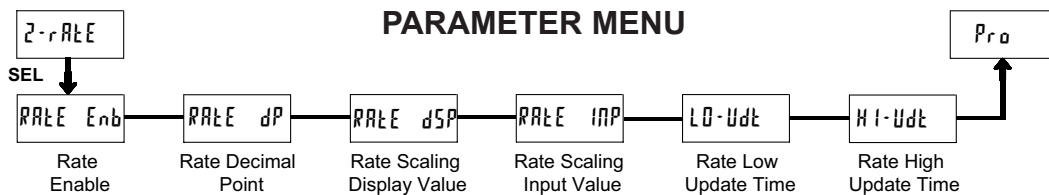

Module 2 is the programming for the rate parameters. For maximum input frequency, Rate Enable should be set to NO when not in use. When set to NO, the remaining rate parameters are not accessible. The rate value is shown with an annunciator of "R" in the Display Mode.

### RATE ENABLE

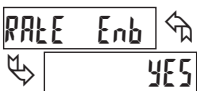

NO YES

### RATE DECIMAL POINT

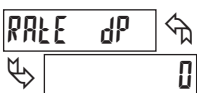

0 000 00000  
00 0000 000000

This selects the decimal point position for the rate display and any setpoint value assigned to rate. This parameter does not affect rate scaling calculations.

### RATE SCALING DISPLAY VALUE

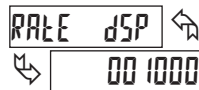

0 to 999999

Enter the desired Rate Display Value for the Scaling Point.\*

### RATE SCALING INPUT VALUE



0.1 to 99999.9

Enter the corresponding Rate Input Value for the Scaling Point.\*

\*For value entry instructions, refer to selection/value entry in the Programming The Meter section.



## SCALING FOR RATE INDICATION

To scale the rate, enter a Scaling Display value with a corresponding Scaling Input value. These values are internally plotted to a display value of 0 and input value of 0.0 Hz. A linear relationship is formed between these points to yield a rate display value that corresponds to the incoming input signal rate. The meter is capable of showing a rate display value for any linear process.

## SCALING CALCULATION

If a display value versus input signal (in pulses per second) is known, then those values can be entered into Scaling Display (RATE dSP) and Scaling Input (RATE INP). No further calculations are needed.

If only the number of pulses per 'single' unit (i.e. # of pulses per foot) is known, then it can be entered as the Scaling Input value and the Scaling Display value will be entered as the following:

RATE PER	DISPLAY (RATE dSP)	INPUT (RATE INP)
Second	1	# of pulses per unit
Minute	60	# of pulses per unit
Hour	3600	# of pulses per unit

## NOTES:

1. If # of pulse per unit is less than 10, then multiply both Input and Display values by 10.
2. If # of pulse per unit is less than 1, then multiply both Input and Display values by 100.
3. If the Display value is raised or lowered, then Input value must be raised or lowered by the same proportion (i.e. Display value for per hour is entered by a third less (1200) then Input value is a third less of # of pulses per unit). The same is true if the Input value is raised or lowered, then Display value must be raised or lowered by the same proportion.
4. Both values must be greater than 0.0.

## EXAMPLE:

1. With 15.1 pulses per foot, show feet per minute in tenths. Scaling Display = 60.0 Scaling Input = 15.1.
2. With 0.25 pulses per gallon, show whole gallons per hour. (To have greater accuracy, multiply both Input and Display values by 10.) Scaling Display = 36000 Scaling Input = 2.5.

## RATE LOW UPDATE TIME

LO-Udt  0.1 to 999 seconds

The Low Update Time is the minimum amount of time between display updates for the rate display. Values of 0.1 and 0.2 seconds will update the display correctly but may cause the display to appear unsteady.

## RATE HIGH UPDATE TIME

HI-Udt  0.2 to 999 seconds

The High Update Time is the maximum amount of time before the rate display is forced to zero. (For more explanation, refer to Rate Value Calculation.) The High Update Time **must** be higher than the Low Update Time and higher than the desired slowest readable speed (one divided by pulses per second). The factory setting of 2.0, will force the display to zero for speeds below 0.5 Hz or a pulse every 2 seconds.

## INPUT FREQUENCY CALCULATION

The meter determines the input frequency by summing the number of falling edges received during a sample period of time. The sample period begins on the first falling edge. At this falling edge, the meter starts accumulating time towards Low Update and High Update values. Also, the meter starts accumulating the number of falling edges. When the time reaches the Low Update Time value, the meter looks for one more falling edge to end the sample period. If a falling edge occurs (before the High Update Time value is reached), the Rate display will update to the new value and the next sample period will start on the same edge. If the High Update Time value is reached (without receiving a falling edge after reaching Low Update Time), then the sample period will end but the Rate display will be forced to zero. The High Update Time value must be greater than the Low Update Time value. Both values must be greater than 0.0. The input frequency calculated during the sample period, is then shown as a Rate value determined by the scaling calculation.

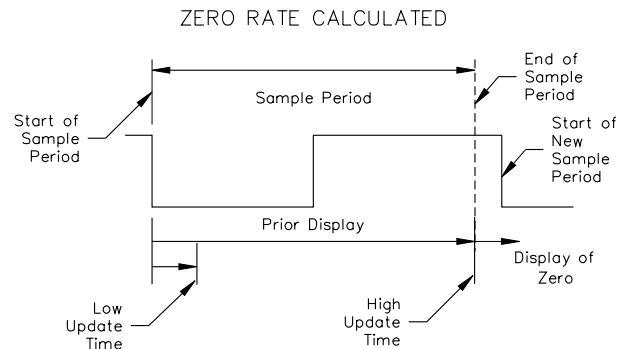
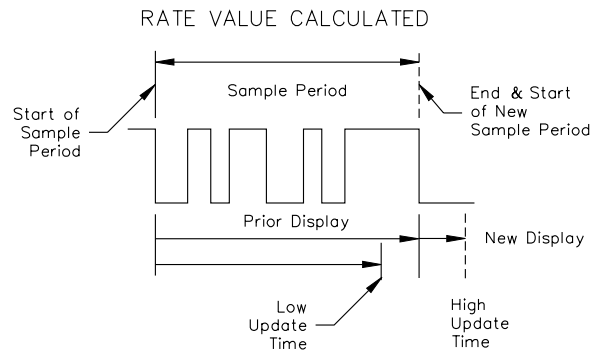

# 6.3 MODULE 3 - DISPLAY AND FRONT PANEL KEY PARAMETERS (3-DISPLAY)

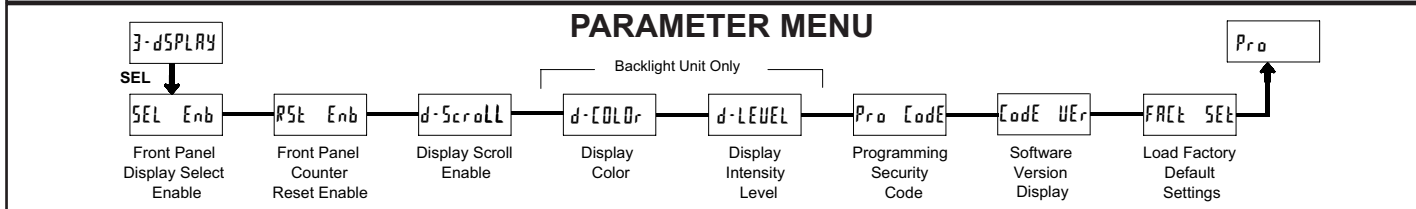

## FRONT PANEL DISPLAY SELECT ENABLE (SEL)

SEL Enb ↵

↵ YES NO

↵ YES

The YES selection allows the SEL button to toggle through the enabled displays.

## FRONT PANEL COUNTER RESET ENABLE (RST)

RSt Enb ↵

↵ YES NO both A-b

↵ YES

NO Count A dSPLAY  
 Count B

The YES selection allows the RST button to reset the selected counter(s). The shaded selections are only active when Counter B is enabled (Dual Count mode or batch counter).

## DISPLAY SCROLL ENABLE

d-ScroLL ↵

↵ YES NO

↵ NO

The YES selection allows the display to automatically scroll through the enabled displays. Each display is shown for 4 seconds.

## DISPLAY COLOR (BACKLIGHT UNIT ONLY)

d-COLOr ↵

↵ rEd grn

↵ rEd

Enter the desired display color, red or green. This parameter is active for backlight units only.

## DISPLAY INTENSITY LEVEL (BACKLIGHT UNIT ONLY)

d-LEVEL ↵

↵ 1 to 5

↵ 5

Enter the desired Display Intensity Level (1-5). The display will actively dim or brighten as levels are changed. This parameter is active for backlight units only.

## PROGRAMMING SECURITY CODE

Pro CodE ↵

↵ 0 to 999

↵ 000

The Security Code determines the programming mode and the accessibility of programming parameters. This code can be used independently or along with the Program Mode Lock-out (Pro Loc) selection in the User Input Function parameter (Module 1).

Two programming modes are available. Full Programming mode allows all unit parameters to be viewed and modified. Quick Programming mode permits only user selected values to be modified, but allows direct access to these values without having to enter Full Programming mode.

Entering a Security Code from 1-99 enables Quick Programming mode, and displays a sublist to select what values appear in the Quick Programming menu. All applicable values set to YES in the sublist will be accessible in Quick Programming. The sublist includes Setpoint values (SP1 UAL, SP2 UAL), Output Time-out values (SP1 TOUT, SP2 TOUT), Counter A Count Load value (CntA Ld) and the Display Intensity Level (d-LEVEL) for backlight units.

Programming any Security Code other than 0, requires this code to be entered at the Pro CodE prompt in order to access Full Programming mode. Quick Programming mode, if enabled, is accessed before the Pro CodE prompt.

USER INPUT FUNCTION	USER INPUT STATE	SECURITY CODE	MODE WHEN "SEL" KEY IS PRESSED	FULL PROGRAMMING MODE ACCESS
not Pro Loc	---	0	Full Programming	Immediate Access
		1-99	Quick Programming	After Quick Programming with correct code entry at Pro CodE prompt *
		100-999	Pro CodE prompt	With correct code entry at Pro CodE prompt *
Pro Loc	Active	0	Programming Lock	No Access
		1-99	Quick Programming	No Access
		100-999	Pro CodE prompt	With correct code entry at Pro CodE prompt *
	Not Active	0-999	Full Programming	Immediate Access

\* Entering Code 222 allows access regardless of security code.

## SOFTWARE VERSION DISPLAY

CodE UEr ↵

↵ NO YES

↵ NO

Select YES to momentarily display the meter software version before advancing to the next parameter. The software version is also displayed at power-up.

## LOAD FACTORY DEFAULT SETTINGS

FACt SEt ↵

↵ NO YES

↵ NO

The YES selection will return the meter to the factory default settings. The meter will display rESEt and then return to Pro, at which time all settings have been changed.

# 6.4 MODULE 4 - SETPOINT OUTPUT PARAMETERS (4-SELEPT)

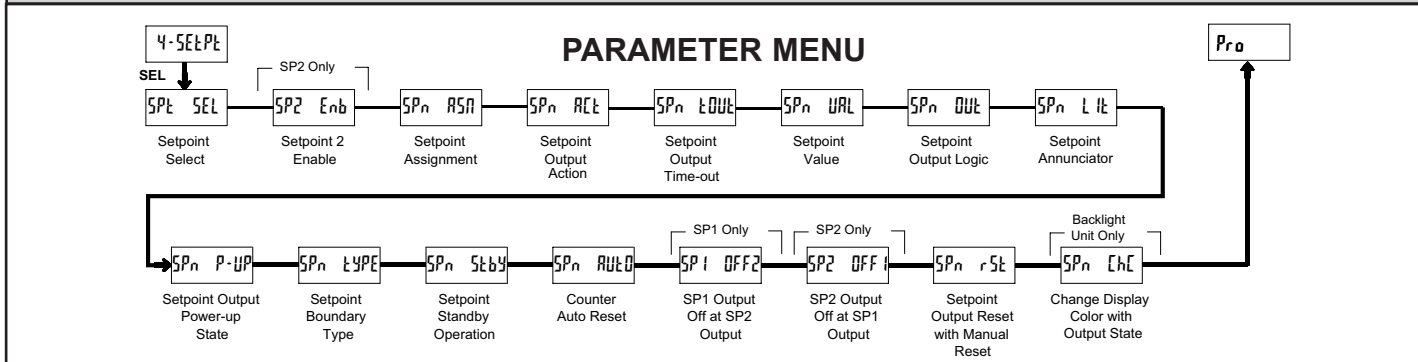

The Setpoint Output Parameters are only active when an optional Setpoint Output Module is installed in the meter. Some parameters in the menu will not appear depending on the Setpoint Assignment and Setpoint Output Action. The Setpoint Parameter Availability chart below illustrates this.

## SETPOINT SELECT



Select the Setpoint Output to be programmed, starting with Setpoint 1. The "n" in the following parameters reflects the chosen Setpoint number. After Setpoint 1 is completely programmed, the display returns to SPt SEL. Repeat steps for Setpoint 2 if both Setpoints are used in the application.

Select NO to exit the Setpoint programming module. The number of Setpoints available is dependent on the Setpoint option module installed.

## SETPOINT 2 ENABLE (SP2 Only)



Select YES to enable Setpoint 2 and access the setup parameters. If NO is selected, the unit returns to SPt SEL and Setpoint 2 is disabled.

## SETPOINT ASSIGNMENT



Select the display to which the Setpoint is assigned.

## SETPOINT OUTPUT ACTION



The parameter selects the action of the Setpoint Output as described in the chart. Boundary output action is not applicable for Counter B assignment.

SPT ACTION	DESCRIPTION	OUTPUT ACTIVATES	OUTPUT DEACTIVATES
LATCH	Latched Output Mode	When Count = Setpoint	At Manual Reset (if SPn rSt=YES)
t-OUT	Timed Output Mode	When Count = Setpoint	After Setpoint Output Time-Out
bOUND	Boundary Mode (High Acting Type)	When Count ≥ Setpoint	When Count < Setpoint
	Boundary Mode (Low Acting Type)	When Count ≤ Setpoint	When Count > Setpoint

## SETPOINT PARAMETER AVAILABILITY

PARAMETER	DESCRIPTION	COUNTER ASSIGNMENT (A or B) *			RATE ASSIGNMENT		
		TIMED OUT t-OUT	BOUNDARY bOUND	LATCH LATCH	TIMED OUT t-OUT	BOUNDARY bOUND	LATCH LATCH
SPn tOUT	Setpoint Output Time-out Value	Yes	No	No	Yes	No	No
SPn VAL	Setpoint Value	Yes	Yes	Yes	Yes	Yes	Yes
SPn OUT	Setpoint Output Logic	Yes	Yes	Yes	Yes	Yes	Yes
SPn LIT	Setpoint Annunciator	Yes	Yes	Yes	Yes	Yes	Yes
SPn P-UP	Setpoint Output Power-up State	No	No	Yes	No	No	Yes
SPn tYPE	Setpoint Boundary Type	No	Yes	No	Yes	Yes	Yes
SPn Stby	Standby Operation (Low acting only)	No	Yes	No	Yes	Yes	Yes
SPn AUTO	Counter Auto Reset	Yes	No	Yes	No	No	No
SP1 OFF2	SP1 Output Off at SP2 (SP1 only)	Yes	No	Yes	No	No	No
SP2 OFF1	SP2 Output Off at SP1 (SP2 only)	Yes	No	Yes	No	No	No
SPn rSt	Output Reset with Manual Reset	Yes	No	Yes	Yes	No	Yes
SPn ChC	Change Display Color w/ Output State	Yes	Yes	Yes	Yes	Yes	Yes

\* BOUNDARY Setpoint Action not applicable for Counter B Assignment

### SETPOINT OUTPUT TIME-OUT

SP<sub>n</sub> **TOU<sub>t</sub>** ↵  
 ↵  001 to 59999 seconds

This parameter is only active if the Setpoint Action is set to time out (t-OUT). Enter the value in seconds that the Setpoint output will be active, once the Setpoint Value is reached.

### SETPOINT VALUE

SP<sub>n</sub> **VAL** ↵  
 ↵  Count A: -9999999 to 99999999  
 Count B: 0 to 9999999  
 Rate: 0 to 999999

Enter the desired Setpoint value. To enter a negative setpoint value, increment digit 8 to display a “-” sign (Counter A only).

### SETPOINT OUTPUT LOGIC

SP<sub>n</sub> **OUT** ↵  
 ↵  NO<sub>r</sub> rEU

Normal (NO<sub>r</sub>) turns the output “on” when activated and “off” when deactivated. Reverse (rEU) turns the output “off” when activated and “on” when deactivated.

### SETPOINT ANNUNCIATOR

SP<sub>n</sub> **LIT** ↵  
 ↵  NO<sub>r</sub> rEU

Normal (NO<sub>r</sub>) displays the setpoint annunciator when the corresponding output is “on”. Reverse (rEU) displays the setpoint annunciator when the output is “off”.

### SETPOINT OUTPUT POWER-UP STATE

SP<sub>n</sub> **P-UP** ↵  
 ↵  OFF ON SAVE

SAVE will restore the output to the same state it was at before the meter was powered down. ON will activate the output at power up. OFF will deactivate the output at power up.

### SETPOINT BOUNDARY TYPE

SP<sub>n</sub> **TYPE** ↵  
 ↵  HI-AC<sub>t</sub> LO-AC<sub>t</sub>

High Acting Boundary Type activates the output when the assigned display value (SP<sub>n</sub> R5N) equals or exceeds the Setpoint value. Low Acting activates the output when the assigned display value is less than or equal to the Setpoint.

### SETPOINT STANDBY OPERATION

SP<sub>n</sub> **Stby** ↵  
 ↵  NO YES

This parameter only applies to Low Acting Boundary Type setpoints. Select YES to disable a Low Acting Setpoint at power-up, until the assigned display value crosses into the output “off” area. Once in the output “off” area, the Setpoint will then function per the description for Low Acting Boundary Type.

### COUNTER AUTO RESET

SP<sub>n</sub> **AUTO** ↵  
 ↵  NO ZErO-StR C<sub>t</sub>Ld-StR  
 ZErO-End C<sub>t</sub>Ld-End

This parameter automatically resets the counter to which the setpoint is assigned (SP<sub>n</sub> R5N) each time the setpoint value is reached. The automatic reset can occur at output start, or at output end if the Setpoint Output Action is programmed for timed output mode. The Reset-to-Count Load selections (“C<sub>t</sub>Ld-”) only apply to Counter A assignment. This reset may be different from the Counter A Reset Action selected in Module 1.

#### SELECTION ACTION

- NO No Auto Reset.
- ZErO-StR Reset to Zero at the start of output activation.
- C<sub>t</sub>Ld-StR Reset to Count Load value at the start of output activation.
- ZErO-End Reset to Zero at the end of output activation (timed out only).
- C<sub>t</sub>Ld-End Reset to Count Load value at the end of output activation (timed out only).

### SETPOINT 1 OUTPUT OFF AT SETPOINT 2 (SP1 Only)

SP1 **OFF2** ↵  
 ↵  NO Out2-StR Out2-End

This parameter will deactivate Setpoint 1 output at the Start or End of Setpoint 2 output (O1 off at O2). The “-End” setting only applies if Setpoint 2 Output Action is programmed for timed output.

### SETPOINT 2 OUTPUT OFF AT SETPOINT 1 (SP2 Only)

SP2 **OFF1** ↵  
 ↵  NO Out1-StR Out1-End

This parameter will deactivate Setpoint 2 output at the Start or End of Setpoint 1 output (O2 off at O1). The “-End” setting only applies if Setpoint 1 Output Action is programmed for timed output.

### SETPOINT OUTPUT RESET WITH MANUAL RESET

SP<sub>n</sub> **rSt** ↵  
 ↵  YES NO

Selecting YES causes the Setpoint output to deactivate (reset) when the Setpoint Assigned Counter is reset. The counter reset can occur by the RST button, User Input, Counter Reset at Power-up or a serial Reset Counter command.

This output reset will not occur when the Assigned Counter is reset by a Setpoint generated Counter Auto Reset.

### CHANGE DISPLAY COLOR WITH OUTPUT STATE

SP<sub>n</sub> **ChC** ↵  
 ↵  NO YES

This parameter enables the backlight CUB5 to switch the backlight color when the output state changes. This parameter is only active for the backlight version.

# 6.5 MODULE 5 - SERIAL COMMUNICATIONS PARAMETERS (5-5Er AL)

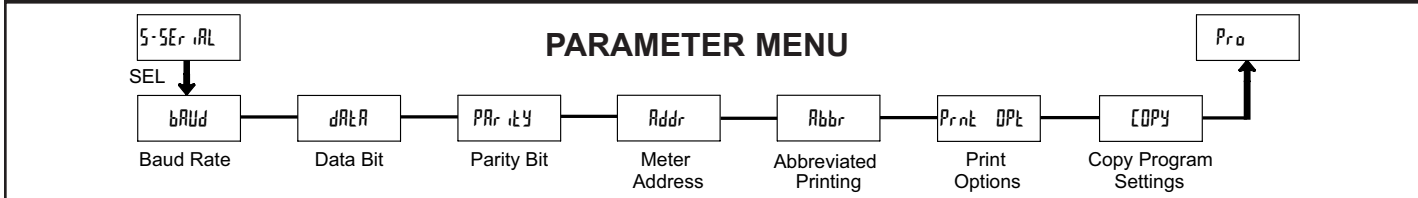

The Serial Setup Parameters are only active when one of the optional serial communication/programming cards is installed in the meter.

Refer to the CUB5USB bulletin for details on the CUB5 USB programming and programming requirements. This section replaces the bulletin shipped with the RS232 and RS485 serial communications plug-in cards. Discard the separate bulletin when using those serial plug-in cards with the CUB5B and CUB5R.

## BAUD RATE

bAUD ↔ ↵  
↵ 9600

300	1200	4800	19200
600	2400	9600	38400

Set the baud rate to match that of other serial communications equipment. Normally, the baud rate is set to the highest value that all of the serial communications equipment is capable of transmitting and receiving.

## DATA BIT

dALtA ↔ ↵  
↵ 7-bit

7-bit 8-bit

Select either 7- or 8-bit data word length. Set the word length to match the other serial communications equipment on the serial link.

## PARITY BIT

PAR tY ↔ ↵  
↵ Odd

NO Odd EVEN

This parameter only appears when the Data Bit parameter is set to a 7-bit data word length. Set the parity bit to match that of the other serial equipment on the serial link. The meter ignores parity when receiving data and sets the parity bit for outgoing data. If parity is set to NO, an additional stop bit is used to force the frame size to 10 bits.

## METER ADDRESS

Addr ↔ ↵  
↵ 00

0 to 99

Enter the serial node address. With a single unit, an address is not needed and a value of zero can be used (RS232 applications). Otherwise, with multiple bussed units, a unique address number must be assigned to each meter. The node address applies specifically to RS485 applications.

## ABBREVIATED PRINTING

Abbr ↔ ↵  
↵ NO

NO YES

This parameter determines the formatting of data transmitted from the meter in response to a Transmit Value command or a Block Print Request. Select NO for a full print transmission, consisting of the meter address, mnemonics, and parameter data. Select YES for abbreviated print transmissions, consisting of the parameter data only. This setting is applied to all the parameters selected in the PRINT OPTIONS. (Note: If the meter address is 0, the address will not be sent during a full transmission.)

## PRINT OPTIONS

Prnt OPT ↔ ↵  
↵ NO

NO YES

This parameter selects the meter values transmitted in response to a Print Request. A print request is also referred to as a block print because more than one parameter can be sent to a printer or computer as a block.

Selecting YES displays a sublist for choosing the meter parameters to appear in the print block. All active parameters entered as YES in the sublist will be transmitted during a block print. Parameters entered as NO will not be sent.

The "Print All" (Prnt ALL) option selects all meter values for transmitting (YES), without having to individually select each parameter in the sublist.

Note: Inactive parameters will not be sent regardless of the print option setting. For example, Counter B or Scale Factor B will only be sent if Counter B is enabled (Dual Counter mode or batch count). Likewise, the Setpoint value(s) will not be sent unless an optional setpoint card is installed in the meter.

DISPLAY	DESCRIPTION	FACTORY SETTING	MNEMONIC
Count A	Counter A	YES	CTA
Count B	Counter B	NO	CTB
RATE	Rate Value	NO	RTE
Scale A	Scale Factor A	NO	SFA
Scale B	Scale Factor B	NO	SFB
SP1	Setpoint 1	NO	SP1
SP2	Setpoint 2	NO	SP2
Count Load	Counter A Count Load	NO	CLD

## COPY PROGRAM SETTINGS

COPY ↔ ↵  
↵ NO

NO YES

This parameter is used to copy all the program settings from one CUB5 meter directly to another CUB5 meter, through the serial communications cards (RS232 or RS485). The USB programming card cannot be used for the copy procedure. No PC connection or additional software is required. Copying program settings eliminates the need for repetitive programming when multiple meters use identical settings.

### Copy Requirements:

- To copy program settings from one meter to another requires the following:
- Both meters must have the same software version (Version 3.1 or later). The version is displayed during the meter power-up sequence, or in Module 3 at the Software Version Display parameter. (See Module 3 for details)
  - The meter receiving the program settings (receiver) must have the Baud Rate set to 9600 baud. Since this is the factory default setting, a new meter will arrive ready for copying. The meter sending the program settings (master) should be set to the desired Baud Rate for the application (if different than 9600). This Baud Rate setting will then be copied to the receiver.

### Copy Connections:

To connect the meters for copying, install a serial communications card of the same type into each meter (RS232 or RS485). Connect the meters using the proper cable listed in the chart.

TYPE	DESCRIPTION	PART NUMBER
RS232	Copy Cable RS232 10' (RJ12-RJ12)	CBLRLC02
RS485	Copy Cable RS485 10' (RJ12-RJ12)	CBLRLCS2

## Copy Procedure:

1. Connect the master and receiver using the appropriate copy cable.
2. Apply power to the meters. The receiving meter must be operating in the normal display mode (not programming mode).
3. On the master meter, enter programming mode and proceed to the Copy Program Settings parameter in Module 5. Select YES to begin copying.
4. During the copy process (~ 2 sec.), the master meter displays an upload message (UP-LOAD) while the receiver displays a download message (dn-LOAD). This indicates successful communication between the master and receiver. If the receiver message is not displayed, be sure the proper cable is connected.
5. When copying is complete, the receiver displays the power-up sequence and returns to normal operating mode, programmed with all the same settings as the master meter. The master remains at the [00P] prompt, ready to connect another receiver for copying.

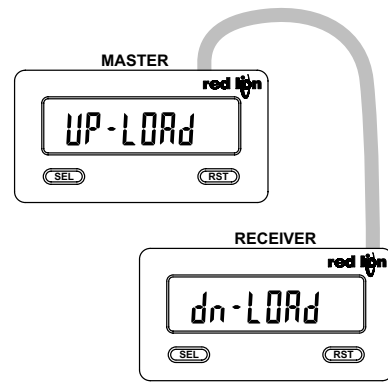

## Sending Serial Commands and Data

When sending commands to the meter, a string containing at least one command character must be constructed. A command string consists of a command character, a value identifier, and numerical data (if writing data to the meter) followed by a command terminator character, \* or \$.

### Command Chart

Command	Description	Notes
N	Node (meter) Address Specifier	Address a specific meter. Must be followed by one or two digit node address. Not required when node address = 0.
T	Transmit Value (read)	Read a register from the meter. Must be followed by a register ID character.
V	Value Change (write)	Write to register of the meter. Must be followed by a register ID character and numeric data.
R	Reset	Reset a count value or setpoint output. Must be followed by a register ID character
P	Block Print Request (read)	Initiates a block print output. Registers in the print block are selected in Print Options.

### Register Identification Chart

ID	Value Description	MNEMONIC	Applicable Commands	Transmit Details (T and V)
A	Counter A	CTA	T, V, R	8 digit positive/7 digit negative (with minus sign)
B	Counter B	CTB	T, V, R	7 digit, positive only
C	Rate	RTE	T	6 digit, positive only
D	Scale Factor A	SFA	T, V	6 digit, positive only
E	Scale Factor B	SFB	T, V,	6 digit, positive only
F	Setpoint 1 (Reset Output 1)	SP1	T, V, R	per setpoint Assignment, same as Counter or Rate
G	Setpoint 2 (Reset Output 2)	SP2	T, V, R	per setpoint Assignment, same as Counter or Rate
H	Counter A Count Load Value	CLD	T, V	8 digit positive/7 digit negative (with minus sign)

### Command String Construction

The command string must be constructed in a specific sequence. The meter does not respond with an error message to illegal commands. The following procedure details construction of a command string:

1. The first 2 or 3 characters consist of the Node Address Specifier (N) followed by a 1 or 2 character node address number. The node address number of the meter is programmable. If the node address is 0, this command and the node address itself may be omitted. This is the only command that may be used in conjunction with other commands.
2. After the optional address specifier, the next character is the command character.
3. The next character is the register ID. This identifies the register that the command affects. The P command does not require a register ID character. It prints all the active selections chosen in the Print Options menu parameter.
4. If constructing a value change command (writing data), the numeric data is sent next.
5. All command strings must be terminated with the string termination characters \* or \$. The meter does not begin processing the command string until this character is received. See Command Response Time section for differences in meter response time when using the \* and \$ terminating characters.

### Command String Examples:

1. Node address = 17, Write 350 to the Setpoint 1 value  
String: N17VF350\*
2. Node address = 5, Read Counter A, response time of 50 msec min  
String: N5TA\*
3. Node address = 0, Reset Setpoint 1 output  
String: RF\*
4. Node address = 31, Request a Block Print Output, response time of 2 msec min  
String: N31P\$

### Transmitting Data to the Meter

Numeric data sent to the meter must be limited to transmit details listed in the Register Identification Chart. Leading zeros are ignored. Negative numbers must have a minus sign. The meter ignores any decimal point and conforms the number to the scaled resolution. (For example: The meter's scaled decimal point position is set for 0.0 and 25 is written to a register. The value of the register is now 2.5. In this case, write a value of 250 to equal 25.0).

*Note: Since the meter does not issue a reply to value change commands, follow with a transmit value command for readback verification.*

## Receiving Data From The Meter

Data is transmitted from the meter in response to either a transmit command (T), a block print request command (P) or a User Input print request. The response from the meter is either a full field transmission or an abbreviated transmission, depending on the selection chosen in Module 5.

### Full Field Transmission

Byte	Description
1, 2	2 byte Node Address field [00-99]
3	<SP> (Space)
4-6	3 byte Register Mnemonic field
7-18	12 byte data field; 10 bytes for number, one byte for sign, one byte for decimal point
19	<CR> (carriage return)
20	<LF> (line feed)
21	<SP>* (Space)
22	<CR>* (carriage return)
23	<LF>* (line feed)

\* These characters only appear in the last line of a block print.

The first two characters transmitted are the meter address. If the address assigned is 0, two spaces are substituted. A space follows the meter address field. The next three characters are the register mnemonic, as shown in the Register Identification Chart.

The numeric data is transmitted next. The numeric field (bytes 7 to 18) is 12 characters long. When a requested counter or rate value exceeds the meter's display limits, an \* (used as an overflow character) replaces a space in byte 7. Byte 8 is always a space.

The remaining ten positions of this field consist of a minus sign (for negative values), a floating decimal point (if applicable), and eight positions for the requested value. The data within bytes 9 to 18 is right-aligned with leading spaces for any unfilled positions.

The end of the response string is terminated with a <CR> and <LF>. After the last line of a block print, an extra <SP>, <CR> and <LF> are added to provide separation between the print blocks.

## Abbreviated Transmission

Byte	Description
1-12	12 byte data field, 10 bytes for number, one byte for sign, one byte for decimal point
13	<CR> (carriage return)
14	<LF> (line feed)
15	<SP>* (Space)
16	<CR>* (carriage return)
17	<LF>* (line feed)

\* These characters only appear in the last line of a block print.

The abbreviated response suppresses the node address and register ID, leaving only the numeric part of the response.

## Meter Response Examples:

- Node address = 17, full field response, Counter A = 875  
17 CTA 875 <CR><LF>
- Node address = 0, full field response, Setpoint 1 = -250.5  
SP1 -250.5<CR><LF>
- Node address = 0, abbreviated response, Setpoint 1 = 250, last line of block print  
250<CR><LF><SP><CR><LF>

## Command Response Time

The meter can only receive data or transmit data at any one time (half-duplex operation). During RS232 transmissions, the meter ignores commands while transmitting data, but instead uses RXD as a busy signal. When sending commands and data to the meter, a delay must be imposed before sending another command. This allows enough time for the meter to process the command and prepare for the next command.

At the start of the time interval  $t_1$ , the computer program prints or writes the string to the com port, thus initiating a transmission. During  $t_1$ , the command characters are under transmission and at the end of this period, the command terminating character (\* or \$) is received by the meter. The time duration of  $t_1$  is dependent on the number of characters and baud rate of the channel.

$$t_1 = (10 \text{ times the \# of characters}) / \text{baud rate}$$

At the start of time interval  $t_2$ , the meter starts the interpretation of the command and when complete, performs the command function. This time interval  $t_2$  varies. If no response from the meter is expected, the meter is ready to accept another command.

If the meter is to reply with data, the time interval  $t_2$  is controlled by the use of the command terminating character. The '\*' terminating character results in a response time of 50 msec. minimum. This allows sufficient time for the release of the sending driver on the RS485 bus. Terminating the command line with '\$' results in a response time ( $t_2$ ) of 2 msec. minimum. The faster response time of this terminating character requires that sending drivers release within 2 msec. after the terminating character is received.

At the beginning of time interval  $t_3$ , the meter responds with the first character of the reply. As with  $t_1$ , the time duration of  $t_3$  is dependent on the number of characters and baud rate of the channel. At the end of  $t_3$ , the meter is ready to receive the next command.

$$t_3 = (10 \text{ times the \# of characters}) / \text{baud rate}$$

The maximum serial throughput of the meter is limited to the sum of the times  $t_1$ ,  $t_2$  and  $t_3$ .

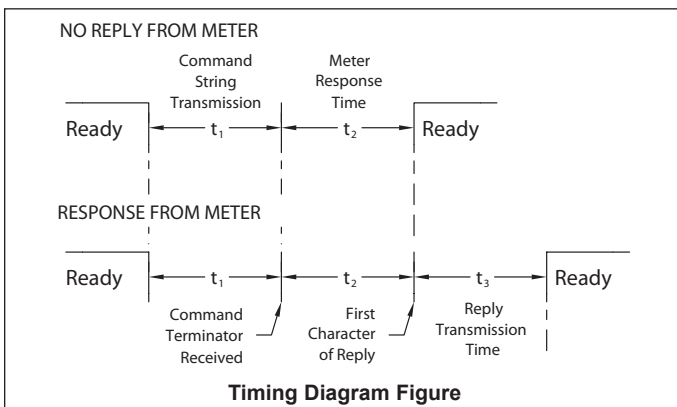

## Communication Format

Data is transferred from the meter through a serial communication channel. In serial communications, the voltage is switched between a high and low level at a predetermined rate (baud rate) using ASCII encoding. The receiving device reads the voltage levels at the same intervals and then translates the switched levels back to a character. The voltage level conventions depend on the interface standard. The table lists the voltage levels for each standard.

LOGIC	INTERFACE STATE	RS232*	RS485*
1	mark (idle)	TXD,RXD; -3 to -15 V	a-b < -200 mV
0	space (active)	TXD,RXD; +3 to +15 V	a-b > +200 mV

\* Voltage levels at the Receiver

Data is transmitted one byte at a time with a variable idle period between characters (0 to ∞). Each ASCII character is "framed" with a beginning start bit, an optional parity bit and one or more ending stop bits. The data format and baud rate must match that of other equipment in order for communication to take place. The figures list the data formats employed by the meter.

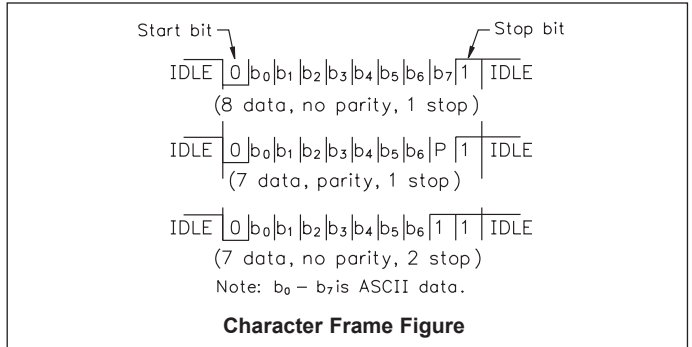

## Start Bit and Data Bits

Data transmission always begins with the start bit. The start bit signals the receiving device to prepare for reception of data. One bit period later, the least significant bit of the ASCII encoded character is transmitted, followed by the remaining data bits. The receiving device then reads each bit position as they are transmitted.

## Parity Bit

After the data bits, the parity bit is sent. The transmitter sets the parity bit to a zero or a one, so that the total number of ones contained in the transmission (including the parity bit) is either even or odd. This bit is used by the receiver to detect errors that may occur to an odd number of bits in the transmission. However, a single parity bit cannot detect errors that may occur to an even number of bits. Given this limitation, the parity bit is often ignored by the receiving device. The CUB5 meter ignores the parity bit of incoming data and sets the parity bit to odd, even or none (mark parity) for outgoing data.

## Stop Bit

The last character transmitted is the stop bit. The stop bit provides a single bit period pause to allow the receiver to prepare to re-synchronize to the start of a new transmission (start bit of next byte). The receiver then continuously looks for the occurrence of the start bit. If 7 data bits and no parity is selected, then 2 stop bits are sent from the meter.

## LIMITED WARRANTY

The Company warrants the products it manufactures against defects in materials and workmanship for a period limited to two years from the date of shipment, provided the products have been stored, handled, installed, and used under proper conditions. The Company's liability under this limited warranty shall extend only to the repair or replacement of a defective product, at The Company's option. The Company disclaims all liability for any affirmation, promise or representation with respect to the products.

The customer agrees to hold Red Lion Controls harmless from, defend, and indemnify RLC against damages, claims, and expenses arising out of subsequent sales of RLC products or products containing components manufactured by RLC and based upon personal injuries, deaths, property damage, lost profits, and other matters which Buyer, its employees, or sub-contractors are or may be to any extent liable, including without limitation penalties imposed by the Consumer Product Safety Act (P.L. 92-573) and liability imposed upon any person pursuant to the Magnuson-Moss Warranty Act (P.L. 93-637), as now in effect or as amended hereafter.

No warranties expressed or implied are created with respect to The Company's products except those expressly contained herein. The Customer acknowledges the disclaimers and limitations contained herein and relies on no other warranties or affirmations.

# CUB5 PROGRAMMING QUICK OVERVIEW

Press and hold SEL key to enter Programming Mode.

